

ASPECT GEN2

THE NEXT GENERATION OF STREET & HIGHWAY LIGHTING

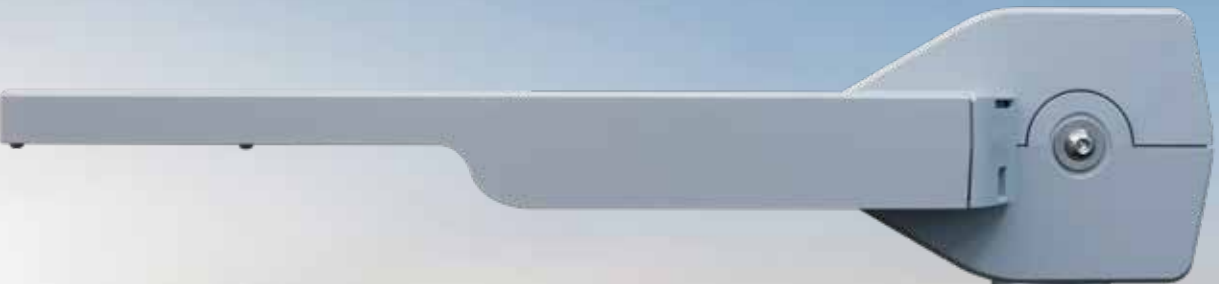

**Simple
installation
and superior
efficiency for
traffic routes and
area lighting**

INTRODUCTION

Developed after 12 years of success with Aspect Gen1, the new Aspect Gen2 product range represents a new standard in street lighting.

This family provides versatility, greater efficiency, and easier installation for traffic routes and area lighting applications, embracing industry, market, and technology advancements over the past decade.

Available in four sizes - 32, 64, 96, and 128 LEDs - the range is adaptable to various lighting requirements. The 96 and 128 LED models are particularly suited for highways, providing robust and reliable illumination.

Supporting a range of colour temperatures such as PC-Amber, 2200K, 2700K, 3000K, and 4000K, Aspect Gen2 provides the required lighting levels for all applications. A 5700K option is available for zebra crossings, prioritising visibility and safety.

The Aspect Gen2 series offers Lumi-LinQ, a wireless system for controlling exterior lighting (see page 7).

TRT Lighting's PowerSet feature is also available; an integrated device for precise power output selection, adjustable either manually or via NFC technology (see page 6).

To enhance the control of light distribution, the Aspect Gen2 is available with either side, front or rear shields.

Combining state-of-the-art design, unparalleled flexibility, and exceptional efficiency, the Aspect Gen2 lanterns are an ideal solution for modern street lighting needs.

128 LED
96 LED
64 LED
32 LED

KEY IMPROVEMENTS



ADVANTAGE 1: IMPROVED EFFICIENCY

The lantern's innovative design incorporates a high transmission, flat glass cover, which improves LED efficiency and optimises light emissions.

Maximum LL/CW is 204

ADVANTAGE 2: IMPROVED INSTALLATION

The patent-granted MountSet universal mounting mechanism removes the need for additional reducers or adapters, ensuring compatibility with all column and bracket types in one unit, while providing a secure fit for both new and existing infrastructure.

Connecting the lantern is simplified by using plug-in connectors, making the process quick, easy, and hassle-free.



ADVANTAGE 3: IMPROVED MAINTENANCE

The Aspect Gen2 lantern ensures straightforward maintenance with its tool-free access and interchangeable heads which seamlessly hinge into place. This design makes lantern replacements and upgrades effortless.

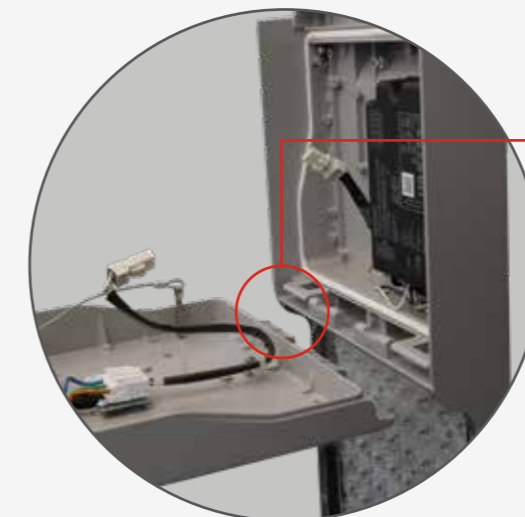

ASPECT GEN2

High transmission flat glass
for optimal LED efficiency

Optional
integrated
breather valve
for pressure
equalisation

National Highways tether
for extra security

Front, rear and side
shield fixing points

UP TO
IK10
RATING

Polyester powder coat
achieving 1000 hour salt
spray resistance

Marine grade high quality
LM6 aluminium alloy body

Pull down
latches for
tool-less access

Tamperproof key
option for vandal
resistance

PowerSet NFC for external
programming of power output,
CLO and dimming regimes

Smooth surface reducing
water/dirt accumulation

IP66
RATING

'MountSet'
(patent granted)
universal
mounting system

POWERSET (NFC OR MANUAL)

An innovative power selection module that provides the end user with the flexibility to easily adjust power and lumen output whether the luminaire is installed or in the depot. The PowerSet feature allows for reduced stock holding with each module specifically designed for the full range of luminaires provided by TRT Lighting.



Employing an NFC remote control, users have the ability to scan a QR code specifying their preferred wattage. The remote is then directed toward the PowerSet panel, allowing the radio signals to transmit seamlessly without the need to open the lantern.



Alternatively, the wattage can be manually adjusted by repositioning a wire within the module to select the appropriate power level.

SMART CITY READY

CMS READY; simply connect with a 7 pin NEMA socket

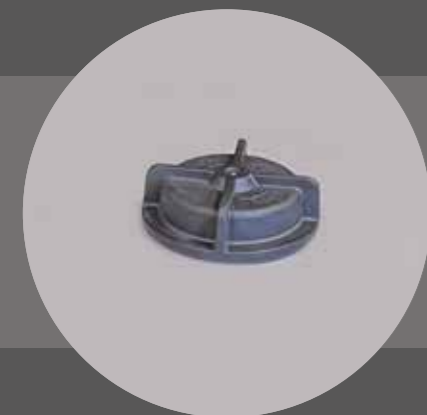

FUTURE PROOF with the latest Zhaga Book 18 socket (top & bottom)

OPTIONAL CONTROL SYSTEM



WIRELESS EXTERIOR LIGHTING CONTROL SYSTEM

LIGHTING CONTROL WITHOUT COMPROMISE

Lumi-LinQ offers energy saving through presence detection and daylight control, user control via Lumi-LinQ scene setting or timed override from the Lumi-LinQ website.

Using the latest high frequency sensor technology a Lumi-LinQ module is mounted directly underneath the LED light engine which is integral to the luminaire therefore protecting these sensitive components. This is ideal for applications where the luminaire aesthetics and impact rating are important factors.

BENEFITS:

- ✓ Lumi-LinQ presence detectors are integral to the luminaire, providing improved impact-resistance and aesthetics.
- ✓ Fully programmable light levels, detection range (sensitivity), time delays and security levels via the Lumi-LinQ programmer.
- ✓ New advanced Lumi-LinQ technology allows photocell control with the LED on or off.
- ✓ Full status monitoring via the Lumi-LinQ website.
- ✓ Automatic testing and record keeping of emergency luminaires via the Lumi-LinQ website.

Find out more at www.trtlighting.co.uk/product/lumi-linq

HIGH PERFORMING OPTICS

In road lighting, optics play a crucial role in determining how light is directed and distributed.

Effective direction and distribution are essential for using the light efficiently, minimising glare, and reducing overspill. This not only enhances visibility on roads—improving safety for drivers and pedestrians—but also lowers energy consumption and limits light pollution, reducing the impact of stray light on neighbouring properties and the environment.

High performing optics in the Aspect Gen2 ensure that illumination is both comfortable and compliant with regulations.

The Aspect Gen2 luminaires are available in the below distributions:

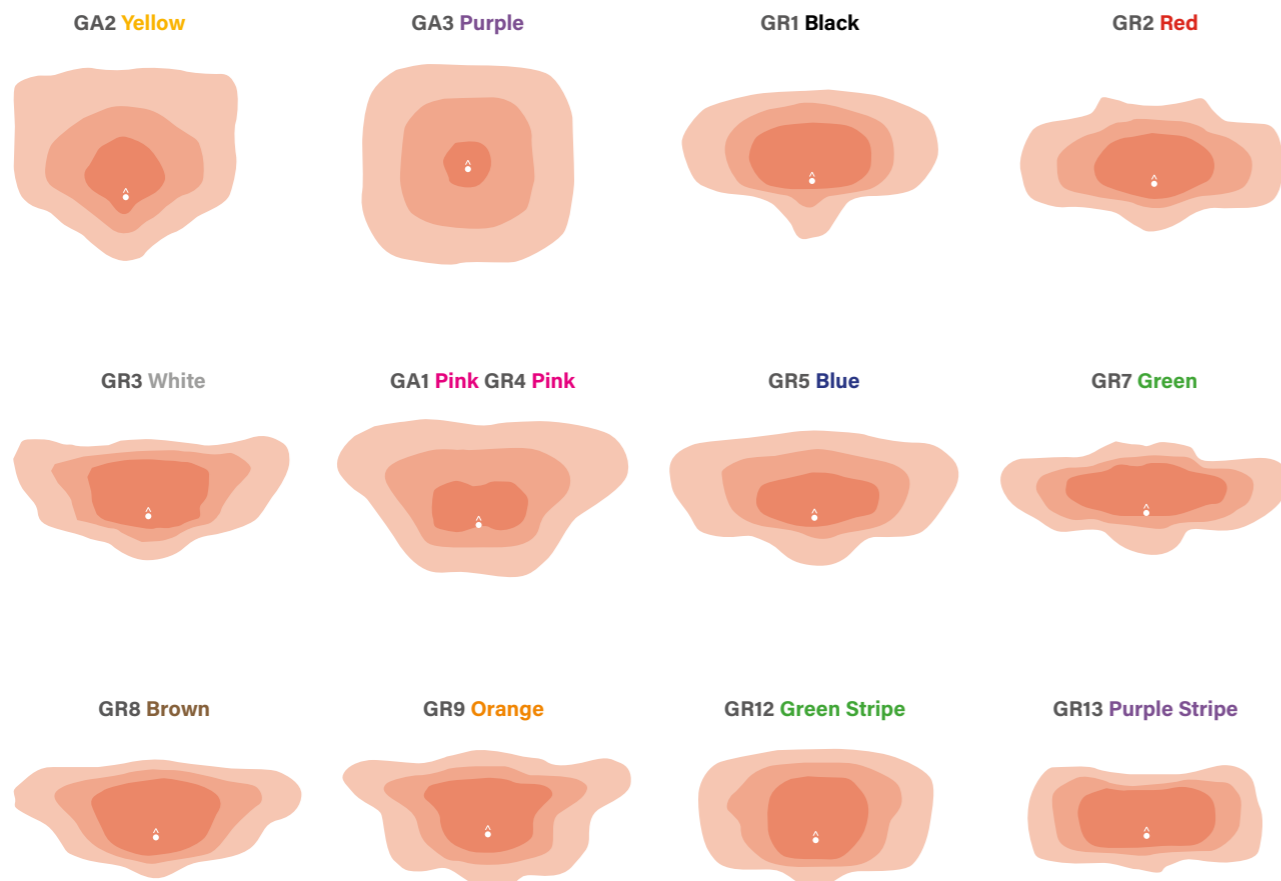

FIXTURES & FITTINGS

Designed and manufactured with precision engineering, Aspect Gen2 offers a suite of innovative features in its fixtures and fittings, ensuring unmatched reliability and longevity.

KEY FEATURES

- ✓ **FIXINGS ON UNDERSIDE ONLY**
eliminate the risk of fluid ponding, dirt buildup, and seizing of screws.
- ✓ **GALVANIC CORROSION PREVENTION**
through no dissimilar metal-to-metal contact and dedicated isolation techniques, ensuring the longevity of the product.
- ✓ **ROBUST CONSTRUCTION**
of an all-aluminium body and mounting. This design eliminates perishing materials while maintaining rigid seals for a robust and weatherproof solution.
- ✓ **STREAMLINED DESIGN**
minimises excessive protrusion, reducing gravitational forces and droop. The largest version (128 LED) measures less than 1 metre in length, including in the side entry position.
- ✓ **OPTIMISED WEIGHT**
is achieved by reducing material content. A lighter overall weight decreases associated headload without comprising structural integrity.
- ✓ **EXTERNAL PIVOT WITH PATENTED MOUNTSET**
ensures the total weight of the luminaire is securely fixed using not only two bolts but also our rotational locking mechanism. This provides exceptional strength and stability, even under greater pressure.



The Aspect Gen2 is more than just a street lantern – it's a statement of advanced engineering and smart design. Experience the future of urban lighting with Aspect Gen2.

INSTALLATION & MAINTENANCE



CONNECTING

The Aspect Gen2 is designed for easy installation - simply plug in the connectors for a quick, straightforward, and hassle-free setup.

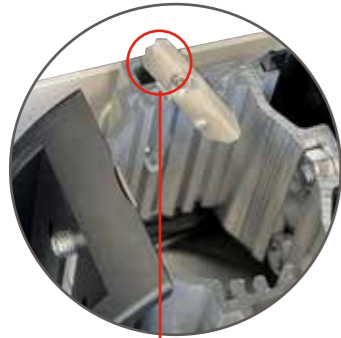

STEP 1
Twist open the locking plate



STEP 2
Move clamp to desired size

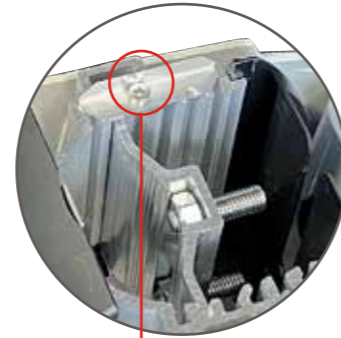

STEP 3
Twist to close locking plate



MOUNTING

MountSet enables the Aspect Gen2 to be mounted onto a wide array of column and bracket sizes without the need for additional reducers or inserts. The dual combination of a stainless steel grub screw and nut means that the lantern is easily removable from the installation at the end of its useful life.

Post top mounting:

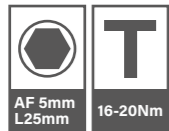

Side entry mounting:

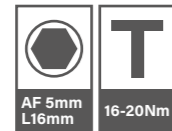

Loosen pivot locking screw to adjust mounting between post top and side entry

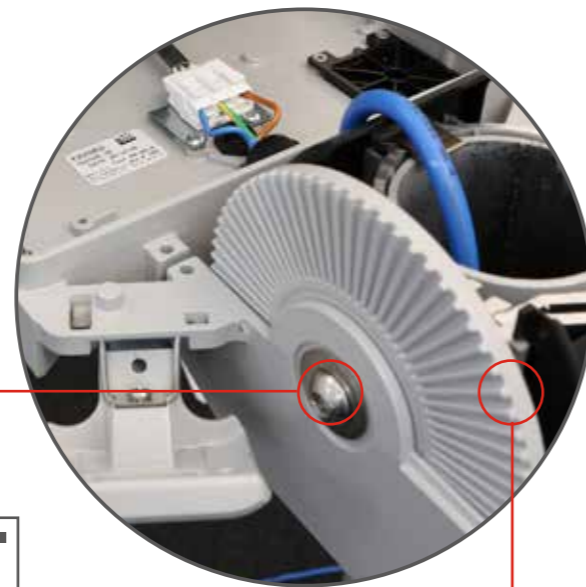
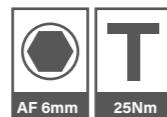

5° increments for easy elevation and declination



SECURING

Once the Aspect Gen2 has been mounted onto the post, it can be securely tethered with a National Highways strap. This optional feature provides extra security, ensuring the lantern remains firmly in place even in the most challenging conditions.

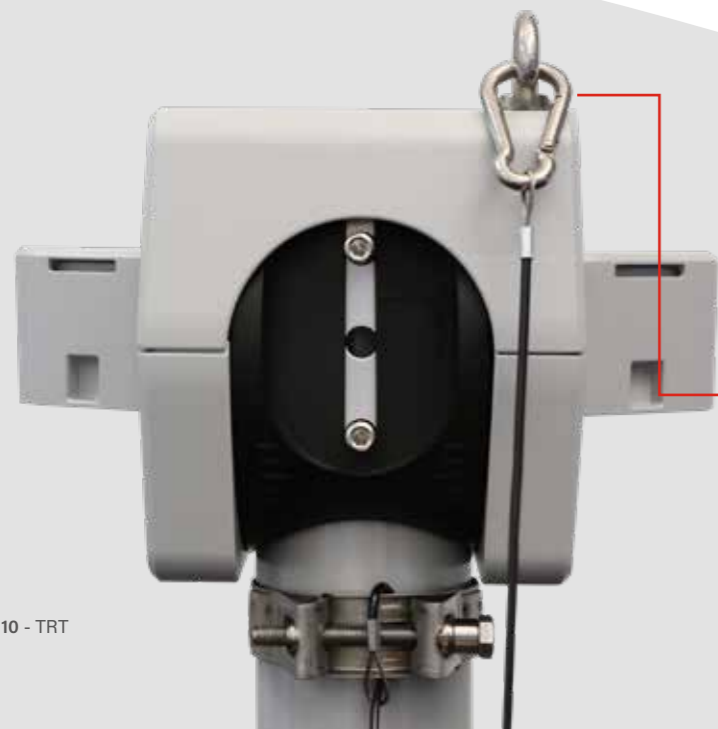

MAINTAINING

Easily interchangeable heads. To swap the head simply:



ASPECT GEN2 SIZES

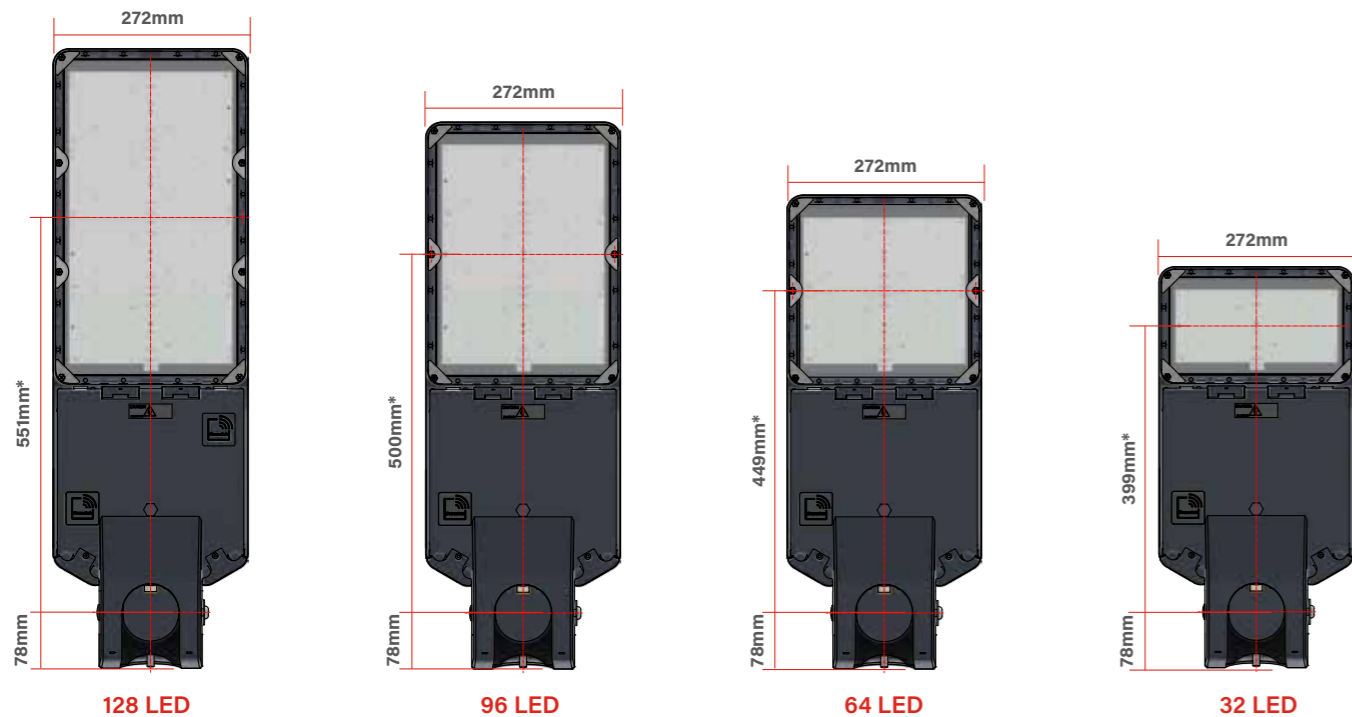

*Photometric Centres

TECHNICAL SPECIFICATIONS



ELECTRICAL CHARACTERISTICS	32 LED	64 LED	96 LED	128 LED
System Power:	37-75W	60-132W	89-199W	154-307W
LED CCT:	PC-Amber*, 2200K, 2700K, 3000K, 4000K (or 5700K Zebra only) (DarkSky approved when using a CCT of 3000K or below and at 0° tilt)			
LED CRI:	>70 (*>48)			
Lumen Output:	Up to 11,825lm	Up to 21,830lm	Up to 32,872lm	Up to 48,945lm
Lumen Maintenance:	Projected L90 after 100,000 hours			
Driver Current:	775mA	700mA	700mA	800mA
Driver Output:	Constant current output with AM dimming			
Power Factor (Full Load/Half Load):	0.95/0.90			
Operational Voltage:	220-240VAC rms			
Operating Frequency:	50/60Hz			
Inrush Current (Apk/50%-µS)	42A/238µS	80A/250µS	80A/225µS	80A/250µS
Running Current (Max):	329mA	579mA	872mA	1,346mA
Surge Protection (COM/DIF):	10kV/6kV			
Additional Surge Protection (on request):	10kV/10kA			
Lighting Controls Options:	NEMA 7, Zhaga Book 18 (SR) socket (top and/or bottom), Photocell, Lumi-LinQ, PND and CMS compatible			
Controls Protocols:	DALI-2 (parts 251 & 253), D4i (optional)			

MECHANICAL CHARACTERISTICS	
Housing Material	Marine grade high pressure die cast LM6 aluminium components
Cover Material	Toughened ultra efficient safety glass cover (polycarbonate cover optional)
Lens Material	PMMA and polycarbonate options
Housing Finish	Chromate free pre-treatment, polyester powder coat light grey (RAL9006), dark grey (RAL7022), black (RAL9005) or bespoke colours on request
Ingress Protection Rating	IP66
Weight	8.1kg (32 LED Version) 9.4kg (64 LED Version) 10.8kg (96 LED Version) 12.5kg (128 LED Version)
Wind Area	0.1233m ² (32 LED Version) 0.1505m ² (64 LED Version) 0.1783m ² (96 LED Version) 0.2058m ² (128 LED Version)
Impact Resistance Rating	IK08 (IK10 with polycarbonate cover)
Mounting Methods	Post top 60mm or 76mm/side entry 34mm, 42mm, 60mm or 76mm
Mounting Inclination	-10°, -5°, 0°, +5° and +10°
Photometric Centre	399mm - 551mm (to centre of PCB)

ACCESSORIES			
Front (All Versions)	83KIT73648	Side (64 LED Version)	83KIT73651
Rear (All Versions)	83KIT73649	Side (96 LED Version)	83KIT73652
Side (32 LED Version)	83KIT73650	Side (128 LED Version)	83KIT73653

DIMENSIONS PERSPECTIVE

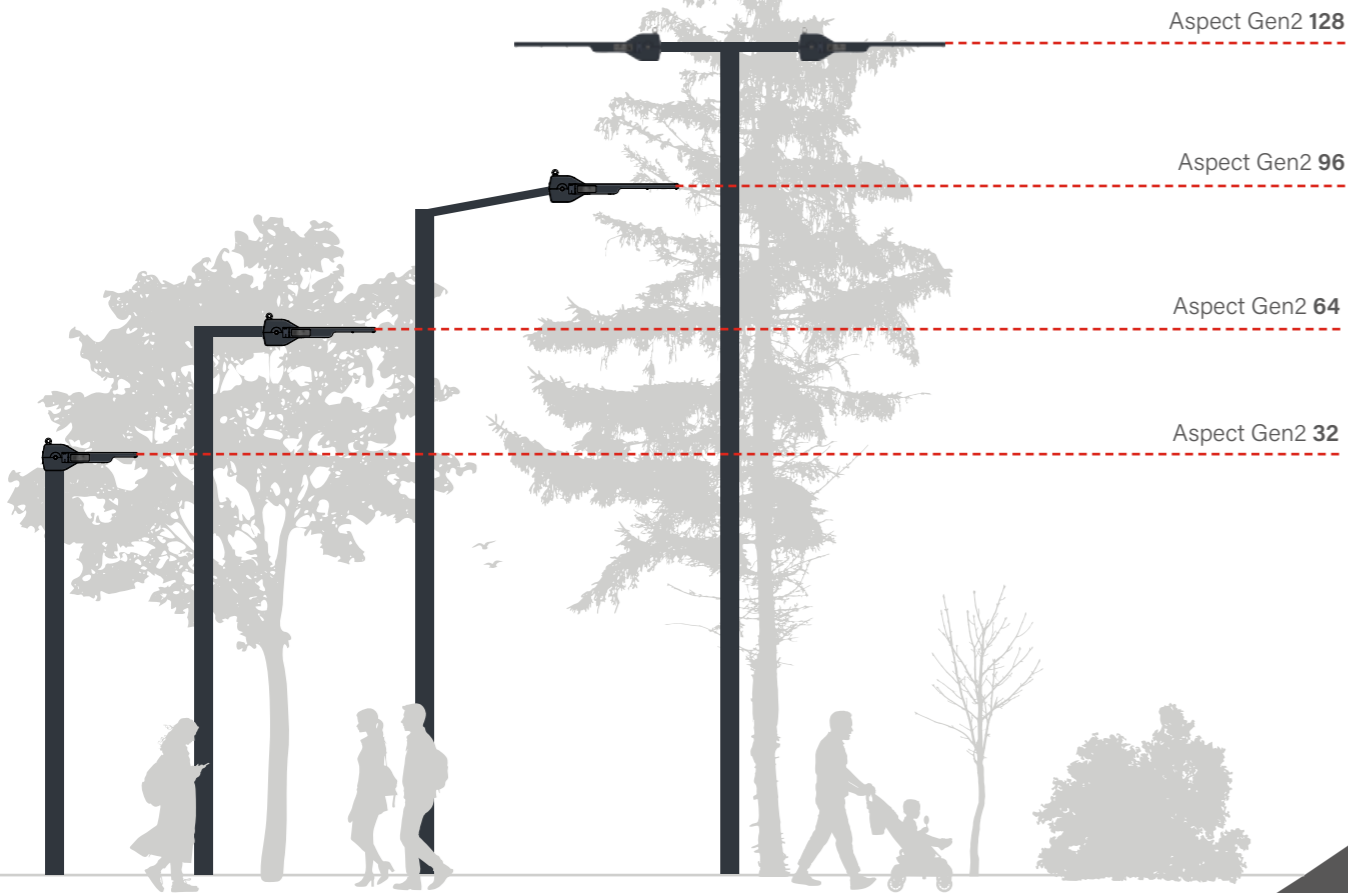

WHERE



TRT is committed to reducing obtrusive light and light trespass in order to protect the night sky from light pollution.

The preservation of the dark sky is critical not only for the well-being of people and wildlife, but also for scientific and astronomical purposes.

The Aspect Gen2 has achieved DarkSky International approval. It is compliant when using a colour temperature of 3000K or below at 0° tilt as this results in no upward light.



DARK-SKY



TRT Lighting are proud to sponsor and support the studies of a PhD Student at the Bat Conservation Research lab at the University of Bath who researches the impact of artificial lighting on bat colonies.



Certified by DarkSky.org

Too often, street lighting installations at night are over lit and are harmful to the environment. As a result, light pollution is a growing global issue that can negatively affect the environment as well as our own quality of life.

By selecting a warmer correlated colour temperature (CCT), the amount of blue light emitted into the night sky is decreased, reducing the harmful effects on flora and fauna.

DarkSky International require a CCT of 3000K or warmer, whilst ecologists such as the Bat Conservation Trust recommend 2700K or warmer for ecological purposes.

The SPD Curves (Spectral Power Distribution) below indicate the blue light emissions at 5700K and 4000K compared to that of lower CCTs.

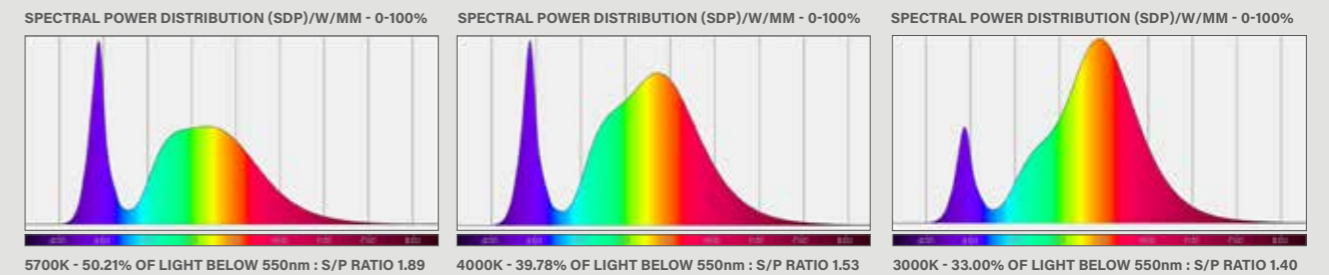

As we move through the warmer CCTs the amount of blue spectral light reduces, this reduces even further.

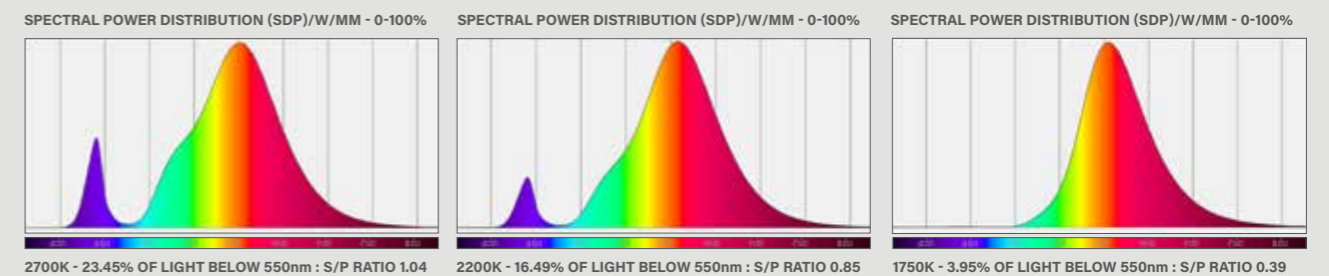

Dark Sky accreditation is approval from a third party for lighting products. This certification is for lanterns that meet DarkSky International standards for light distribution, shielding, and colour temperature.

CIRCULARITY

CIRCULAR DESIGN

Aligned with circularity principles that focus on minimising waste and maximising the lifespan of materials, TRT designs all its products with an emphasis on minimal components, durability, and reparability.

The Aspect Gen2 exemplifies these principles with its long-lasting design, each component purposefully engineered for disassembly and recyclability to ensure materials can be efficiently recycled and repurposed at the end of product life.

The TM66 Assured Product Verification Scheme is an innovative program developed by the Lighting Industry Association (LIA) and endorsed by the Chartered Institution of Building Services Engineers (CIBSE). The TM66 score evaluates a product's performance within the Circular Economy framework, and the Aspect Gen2 has achieved an 'excellent' score of 2.7, underscoring its exceptional circularity.

PACKAGING

TRT ensures its products are delivered in 100% recyclable packaging significantly reducing environmental impact without compromising on protection or safety. By eliminating plastics, TRT has reduced embodied carbon (CO₂e/kg) by 43% annually. To minimise waste further, customers can request that lanterns are layered in cartons with cardboard separators, rather than being individually boxed. TRT offers a free collection service for cardboard and wooden pallets.

WEEE

TRT fully complies with the UK WEEE Regulations 2006 and demonstrates its commitment through membership in a registered compliance scheme. Since 1st January, 2023, TRT's WEEE membership has been held with Recolight, the UK's leading lighting compliance organisation. Every luminaire supplied by TRT includes a WEEE levy to cover end-of-life disposal costs, ensuring customers benefit from a waste collection service at no additional charge.

Up to 95% of materials are re-used and hazardous substances are safely extracted.



SUSTAINABILITY

The FW Thorpe Group of companies has been officially recognised as being carbon neutral, with systems of reduction, measurement and certified offsetting in place since 2012.

In 2009 FW Thorpe designed an ambitious carbon offsetting scheme. 179,412 trees have been planted on 215 acres in Wales sequestering over 44,385 tonnes of CO₂e over a period of 100 years.

TRT Lighting, as part of FW Thorpe Plc, has had its net-zero target validated by the Science Based Targets Initiative (SBTi) under the Net Zero Standard.

MADE IN BRITAIN

TRT Lighting manufactures its luminaires in Redditch, Worcestershire and is a proud member of the official Made in Britain campaign and its Green Growth programme.

 **179,412**
trees planted
on 215 acres



10 YEAR WARRANTY (MINIMUM)

ASPECT GEN2 ORDER CODES

■ MANDATORY ■ OPTIONAL

STEP 1	STEP 2	STEP 3	STEP 4	STEP 5	STEP 6	STEP 7	STEP 8	STEP 9	STEP 10	STEP 11	STEP 12	STEP 13	STEP 14	STEP 15
Select Product Variant	Select Wattage	Select Distribution	Select CCT	Select Colour	Select Cover	Select Mounting	Controls	Flying Lead	Vent Plug	Eyebolt Tether	Marine Grade Finish	Part Night Step 1	Part Night Step 2	Part Night Step 3
A32 Standard Aspect Gen2 32 LED	C = Constant Light Output (CLO) P = *Manual PowerSet CP = Constant Light Output (CLO) & *Manual PowerSet	GA1 = General Area 1 GA2 = General Area 2 GA3 = General Area 3	57 = 5700K 4 = 4000K 3 = 3000K 27 = 2700K 22 = 2200K A = PC-Amber	L = Light Grey D = Dark Grey B = Black	G = Glass P = Polycarbonate	P76 = 76mm Post Top Entry P60 = 60mm Post Top Entry S60 = 60mm Side Entry S76 = 76mm Side Entry S42 = 42mm Side Entry S34 = 34mm Side Entry UNI = Universal	N7 = 7 Pin NEMA Socket N7C = 7 Pin NEMA with Photocell ZB = Zhaga Book 18 Socket (Bottom) ZTB = Zhaga Book 18 Socket (Top & Bottom) ZTC = Zhaga Book 18 Socket (Top) with Photocell LL = Lumi-LinQ	7A1-17A1 = 7m up to 17m of 3-Core Arctic 1.5mm ² Cable 7A2-17A2 = 7m up to 17m of 3-Core Arctic 2.5mm ² Cable	V = Vent Plug	E = Eyebolt Tether	M = Marine Grade	PN = Factory set part night dimming 752022 = eg: 75%: from 20:00 until 22:00	5000 = eg: in addition to Part Night Step 1, dim to 50% until 00:00	7506 = eg: in addition to Part Night Step 2, dim to 75% until 06:00
A64 Standard Aspect Gen2 64 LED														
A96 Standard Aspect Gen2 96 LED														
A128 Standard Aspect Gen2 128 LED														

EXAMPLE: A64 CP / 300 / GR12 / 57 / L / G / P76 / N7C / 17A1 / V / E / M / PN 752022 / 5000 / 7506

*NFC PowerSet is integrated as standard in all versions. Manual PowerSet optional in 32, 64 and 96 LED versions only.



TRT Lighting Ltd

Heming Point | Claybrook Drive | Washford Ind Est | Redditch | B98 0FH | United Kingdom

t +44 (0)1527 521162 **e** info@trtlighting.co.uk

www.trtlighting.co.uk